





SETUP

Installation

Power Inverter 4.0 / 6.0

EN

This setup manual contains a short instruction required for installing, wiring, commissioning and operating the inverters. For further instructions on installing or operating, please refer to the detailed user manual which you can access via www.rct-power.com. RCT Power GmbH reserves the right to make changes to specifications or documents without prior notice. RCT Power GmbH shall not be responsible for any damages resulting from use of this document. This document does not replace any applicable laws, regulations, standards or codes. Warranty conditions come enclosed with the device. No warranties can be derived from this document.

Symbols Explanation	Level of risk		
	high	medium	low
Immediate danger of death or serious injury	 DANGER	 WARNING	
Immediate danger of minor or moderate injury			 CAUTION
Danger of equipment or property damage		 NOTICE	

Intended Product Usage



To prevent personal injury or property damage, the inverter must only be installed, wired, connected, commissioned, maintained and serviced by qualified personnel:

- Trained in installing electrical devices.
- Familiar with all applicable laws, regulations, standards and codes for electrical devices.
- Familiar with safety requirements and safety-related guidelines for electrical devices.
- Familiar with work protection laws and regulations.
- Using the appropriate personal protective equipment.

Power Inverter 4.0 and 6.0 are stationary 3-phase string inverters. They convert direct current (DC) supplied by the PV array into alternating current (AC), which can be fed into the electricity grid.

They are not designed for any other application or connection to other devices.

Any use that differs from or goes beyond the intended usage is considered misuse. RCT Power GmbH shall not be liable for any damage resulting from misuse.

Any misuse will terminate warranty, guarantee and general liability of the manufacturer.



Assembly and mounting.
(Section 2, p.3).



Electrical connection of the devices.
(PV and grid section 3, p.4-5 /
Communication section 4, p.6 and section 5, p.7).



Switch on Inverter (switch on fuses).
(Section 6.1, p.8).



Access to the inverter via APP.
(Steps 1 to 7 in section 6.2, p.8-9).



Configure the inverter, select the land and norm.
(Steps 8 to 12 in section 6.3, p.10).



Now setup procedure is completed.
The inverter starts feeding after checking normative specifications.

[1] Scope of Delivery

Item	Description
A	Setup manual
B	PV input connectors (Weidmüller PV-Stick)
C	Wall bracket for mounting inverter
D	Inverter
a	LCD display for information on inverter operation
b	DC switch for emergency shutdown of inverter
c	DC plugs
d	Cable entries for communication ports
e	Cable entry for AC cable
f	Screw hole for additional protective grounding
g	Name plate with technical data, serial number, symbols:

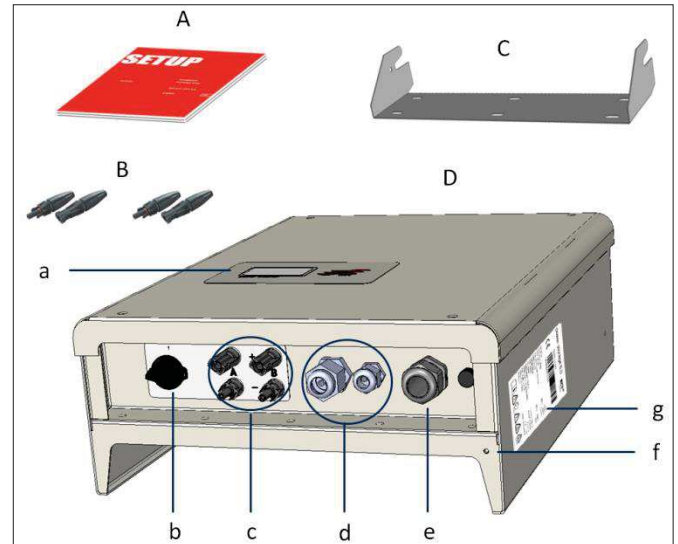



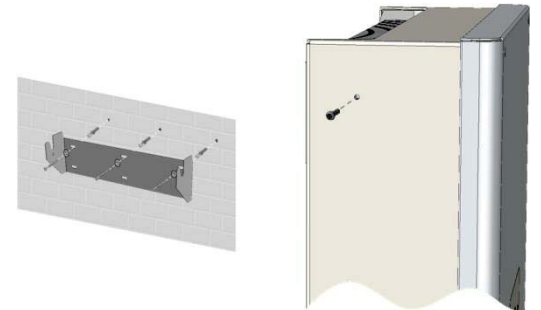
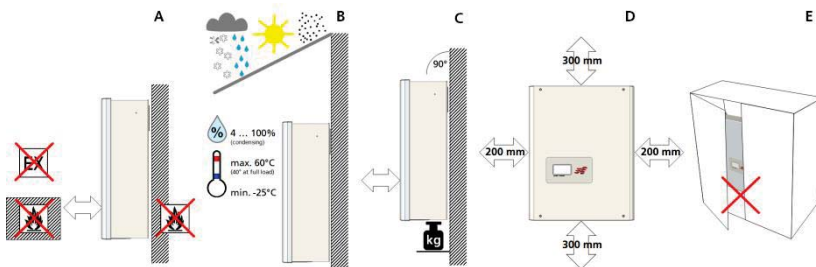

Fig.1

 Look over user manual.	 Wait 10 minutes after disconnection before touching inner parts.
 Hot surface	 Electrical device: grounding necessary

[2] Inverter Mounting



Item	Description
A	Select non-flammable, firm wall. Room may not contain highly flammable goods, liquids or gas. Protect from snow, rain, direct sunlight and dust.
B	Observe allowed ambient temperature [-25 ... 60°C]. Maximum degree of pollution PD3.
C	Mount in upright position. Ensure enough space for easy access. Make sure wall supports inverter weight.
D	Minimum clearance: half of inverter width at both sides and half of height at top and bottom.
E	Do not place inverter in closed cabinet.

Step	Description
1	Attach wall bracket firmly to wall with 3 to 6 screws (ø 6 to 8 mm), matching wall plugs and washers (outer ø min. 18 mm). <i>Material not included in delivery.</i>
2	Take out locking screw of inverter housing. Hook inverter onto wall bracket and fix locking screw back.

[3] Electrical Connection



Risk of death or injury due to electric shock!
While the inverter is connected to grid (AC voltage source) or to PV array which is exposed to sunlight (DC voltage source) high voltage is present in cables and inner parts of inverter.

- **Important: Both voltage sources (DC/PV-generator and AC/ utility grid) must be disabled before any electrical work.**
To disable DC voltage connection turn DC switch to 0-position and wait 10 minutes before continuing.
To disable AC voltage connection turn off AC switch, main breaker or fuse. Make sure, other persons don't switch back.
Do not enable voltage connections until work is finished.
- During DC connection: Do not touch positive and negative cable endings at the same time!
- During AC connection: Do not exchange L, N and PE wires!
- Make sure other persons keep away during electrical work.



Risk of death or injury due to electric arc!
Disconnecting DC plugs under load can cause electric arcs.



Risk of damage due to improper installation and operation or misuse.

- Contact local utility company or grid operator before connecting inverter to grid.
- Provide for an AC disconnection device (typical miniature circuit breaker 3 pole 6kA, B – characteristic 16 A).
- If required in country or installation, install a residual-current device (RCD), or residual-current circuit breaker (RCCB).
- Inverter contains no owner serviceable parts. Contact local authorized personnel for service.
- Do not remove name plate.

[3.1] Overview Connection Parts

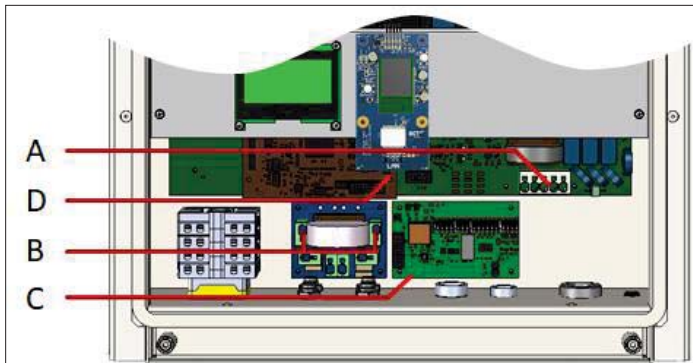
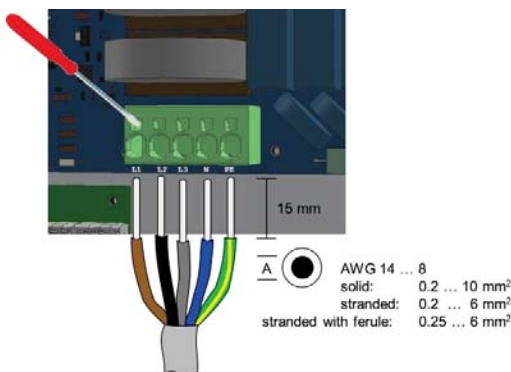

Fig. 2

Item	Description
A	AC terminal block for L1, L2, L3, N and PE phases.
B	Clamps for parallel DC mode.
C	Communication board.
D	Ethernet terminal

[3.2] AC Connection



Step	Description
1	Remove cover of inverter. Locate AC terminal block (Fig. 2, A).
2	Feed cable through AC entry (Fig. 1, e). Push down clamps to insert L1, L2, L3, N and PE.
3	Tighten swivel nut of cable entry.

[3.3] DC Connection

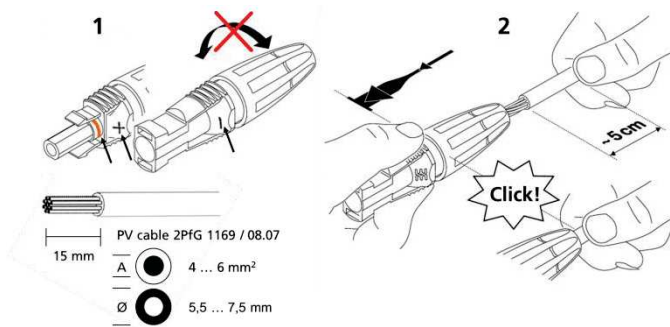

Step	Description
1	Do not turn plug parts before inserting the cable. Select correct plugs for polarity of PV strings.
2	Push cable into plugs straight until the spring clamp locks.
3	Turn lower part of plug shut.
4	Make sure DC switch is "0". Plug corresponding plus and minus poles into adjacent plugs of inverter (Fig. 1, c).

[3.4] DC Parallel Mode

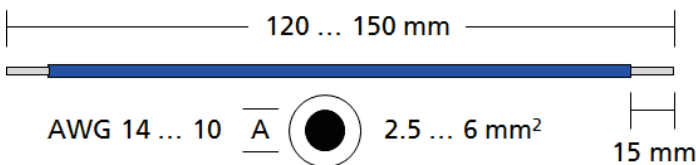

Material not included in delivery.

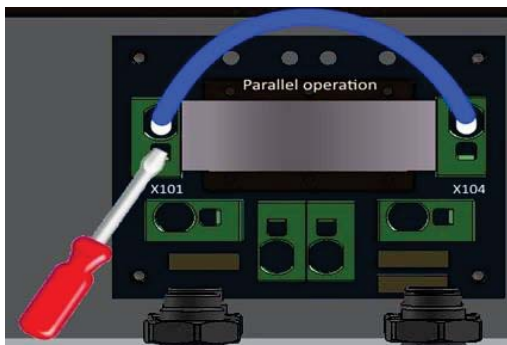

This section applies only, if several Strings with an equal amount of modules are to be connected in parallel and the maximum input current per input therefore exceeds 12A.



WARNING

To prevent personal injury or property damage, make sure that there is no PV-DC connector plugged and DC-switch is "0" in during this installation.

Step	Description
1	Remove cover of inverter.
2	Connect clamps X101 and X104. (see Fig. 2, B).

[3.5] Second Protective Grounding

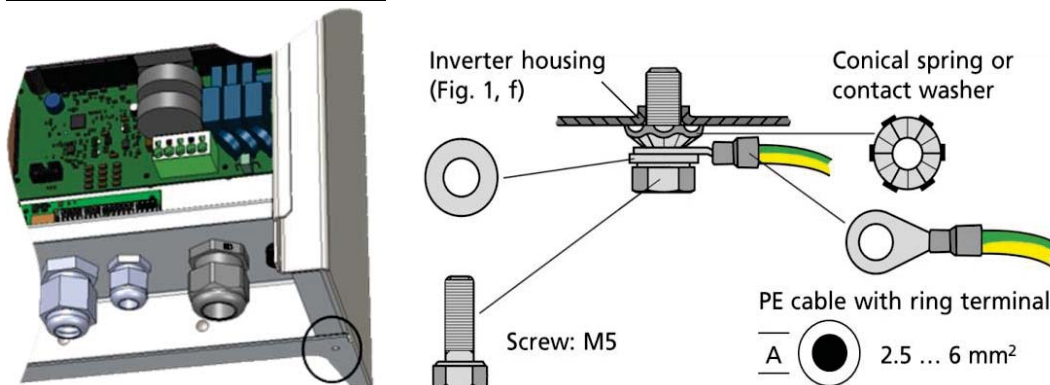

Material not included in delivery.

If required in the country of installation, attach a second protective earth connection to the Power Inverter housing.

[4] I/O-Board Communication Connection

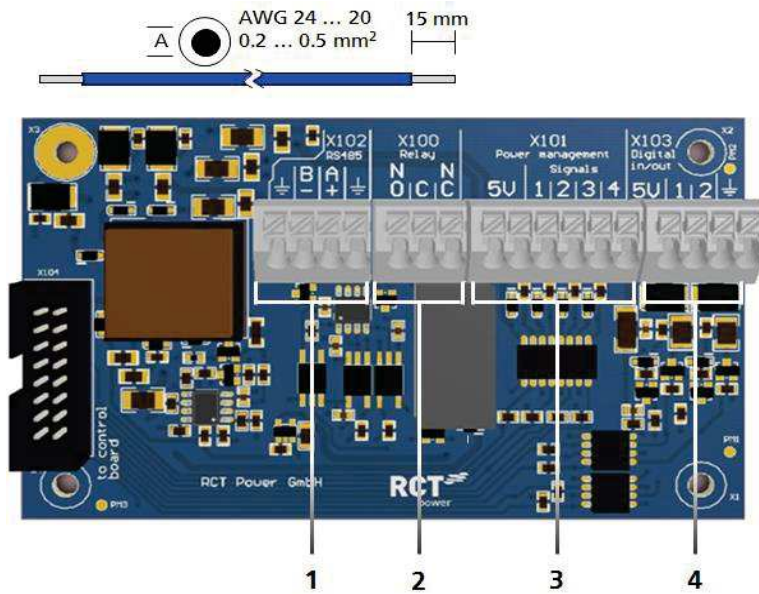

Fig.3

Communication Ports

Item Description

- | Item | Description |
|------|---|
| 1 | X102: serial RS485 interface. |
| 2 | X100: Multifunctional Relay, max. 24 V, 1A. |
| 3 | X101, Power management: 4 digital inputs for potential free relay contacts. |
| 4 | X103: Digital in/out (S0 signals) max. Input 24 V, max. output 5 V 10 mA |

[4.1] Connection of Communication Ports

Step Description

- | Step | Description |
|------|---|
| 1 | Open cable entry (Fig. 1, d) and feed cables. |
| 2 | Select correct port (see next section), press down spring clamp, insert cables and release. |

[4.2] Wiring of Communication Ports

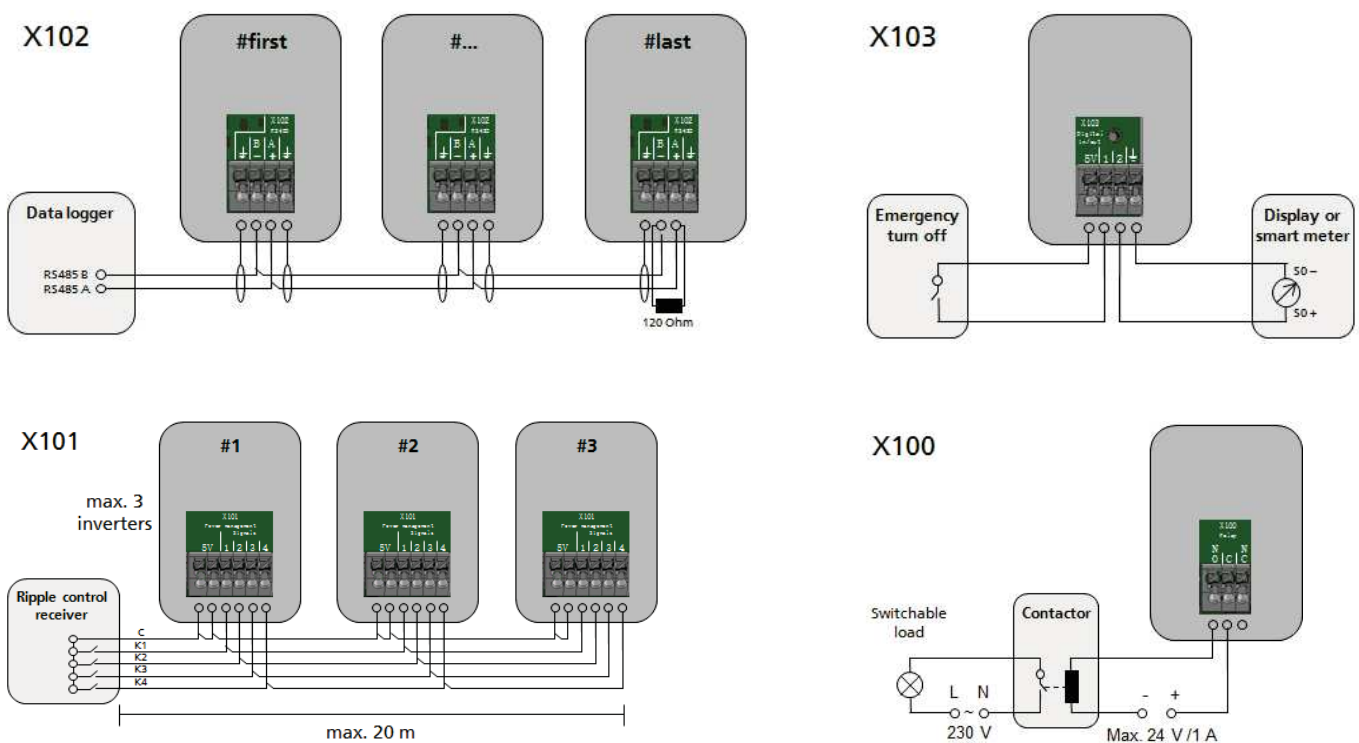

[5] Connection – Ethernet-Interface

In addition to Wi-Fi-communication, the Power Inverter offers the option to communicate via an Ethernet interface after initial start-up.

For this, a corresponding network cable (at least Cat5e) must be connected to the Power Inverter and the corresponding terminal (preferably a router).

The configuration of this connection is made via the menu item „network settings“ in the RCT Power App and is explained in the manual.

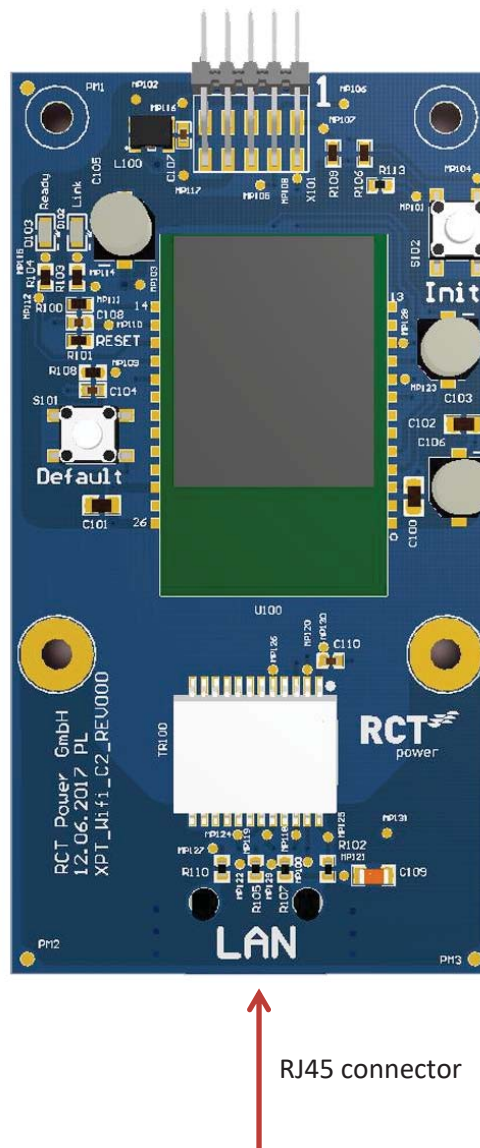

Step	Description
1	Open cable entry (Fig. 1, d) and feed the cable.
2	Select correct port, insert cable in RJ45 connector.

[6] Commissioning

Ensure proper mechanical and electrical installation before commissioning the Solar Inverter.

Check the cables to ensure that they are in sound condition.



CAUTION

Always disconnect the mains connection first by switching off the corresponding mains fuse and before disconnecting the solar generator side by opening the DC load break switch.

The DC-connectors on the solar generator side must not be disconnected under load. First turn the DC load break switch to position 0.

Further configuration inter alia for the networking of RCT Power devices via LAN / WLAN can be found in the manual on our website www.rct-power.com.

[6.1] Switch on Inverter

Step	Description
1	Establish grid connection via the external circuit breaker.
2	Switch on the solar generator voltage by closing the DC load break switch (position 1). The solar Inverter starts operating when the input voltage level and power is adequate.

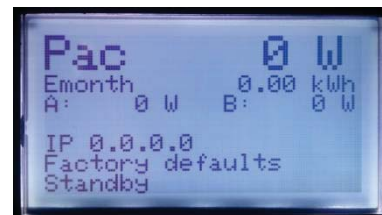

NOTICE

Please note that the inverter is powered by PV modules.

Accordingly a start of the power supply and thus commissioning only with sufficient irradiation is possible.

[6.2] Access to the inverter



NOTICE

The Solar Inverter is equipped with an internal Wi-Fi unit. To set up Solar inverter you need to access via Wi-Fi due to the suitable Android APP.

The Android APP is the central user interface for commissioning. It ensures easy data collection and troubleshooting.

Obtaining Android App: Go to Google Play Store, search for "RCT Power App", and install.

Step Description

1 Activate WLAN on your smartphone (or tablet computer).

2 Connect with SSID identical with the name of the Power Inverter on inverter display via Wi-Fi. (e.g. PI 6.0 CHN0).



If the Inverter is already in a network via Wi-Fi, connect to the network.

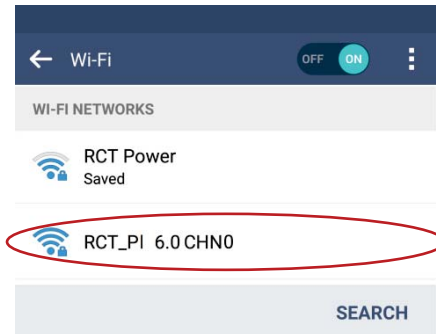

3 If you connect the first time with a device to the inverter you need a password. The password corresponds to the serial number of your device (see display or name plate).

RCT_PI 6.0 CHN0

Only an example!

Password

0066A2600005

Show password

Show advanced options

CANCEL CONNECT

4 Start "RCT Power APP".



5 Switch to tab "network" and press "Scan".

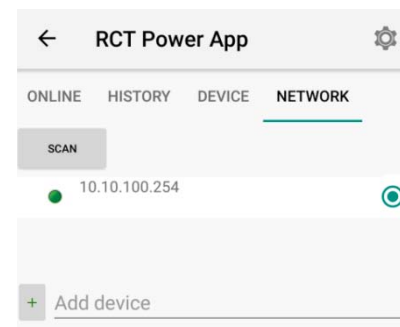

6 Activate "10.10.100.254" (or if you have renamed the device choose this) by choosing radio button.



7 If the connection is made with an inverter, the name is displayed on the head and the icon is edged.

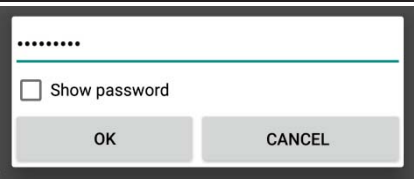
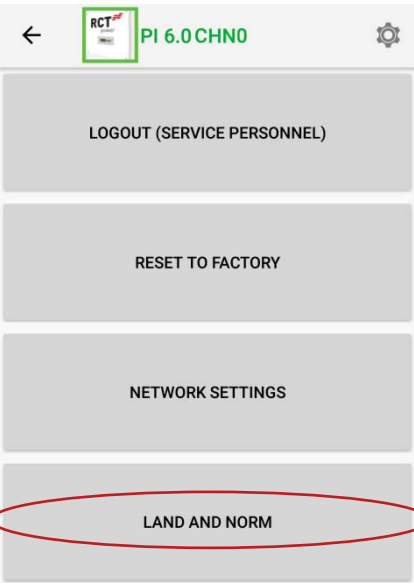
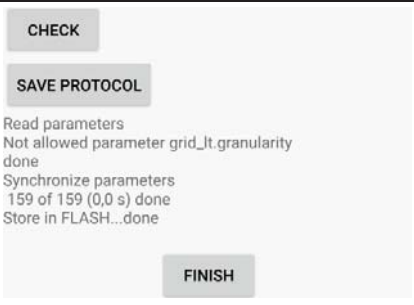
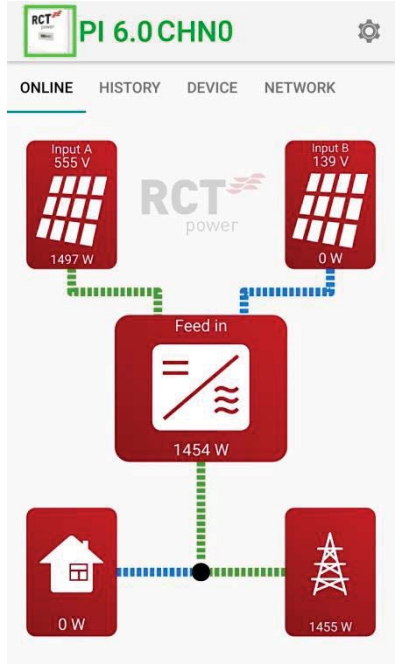

[6.3] Configure Inverter

8	Press "  ".	
9	Enter setup procedure by "Login" with suitable password for installer-level	
10	Choose „Land and Norm“, select appropriate norm and „apply“.	
11	Wait during parameters are synchronizing and stored. When finished type „Finish“.	
12	Now setup procedure is completed. After the inverter has checked the specifications it starts feed in into the grid. Press "return" to get on start page.	

Note: For further information on installation and operation, please refer to the detailed user manual, which can be obtained from our website www.rct-power.com.

[7] How to switch off the system

Step	Description
1	Locate DC switch (Fig. 1, b) and turn to „0“ position.
2	Switch if circuit breaker, main breaker or fuse disconnecting inverter from utility grid.
3	Wait min. 10 minutes until capacitors have discharged.
4	Remove DC connectors (Fig. 1, c). Press latches of male plug together to unlock and pull off DC plugs.

[8] Technical Data

Power Inverter	4.0	6.0
Order Number	IXP040N1AE0	IXP060N1AE0
DC-INPUT		
Max. recommended DC power	5000 W	7500 W
MPPT	2 (paralleling possible)	
Input per MPPT	1	
Maximum DC current per MPPT	2 x 12 A (1 x 24 A in parallel mode)	
Rated DC voltage	700 V	
DC start up voltage / power	150 V / 25 W	
DC voltage range	140 V ... 1000 V	
MPP voltage range	200 V ... 800 V	265 V ... 800 V
Maximum voltage DC	1000 V	
Connectors type	Weidmüller PV-Stick (MC4 compatible)	
AC-OUTPUT		
Rated AC output power	4000 W	6000 W
Maximum active power	4000 W	6000 W
Maximum apparent power	6300 VA	6300 VA
Nominal AC current per phase	5,8 A	8.7 A
Maximum AC current per phase	9,1 A	9.1 A
Rated frequency	50 Hz / 60 Hz	
Frequency range	45 Hz ... 65 Hz	
Max. switch-on current	13 A, 0,1ms	
Max. fault current (RMS)	285 mA	
Rated AC voltage	230V / 400 V (L1, L2, L3, N, PE)	
AC voltage range	180V ... 290V	
Total harmonic distortion (THD)	< 2% @ rated power	
Reactive power factor (cos phi)	1 (adjustable range 0,8 cap....0,8 ind)	
Anti-islanding operation	Yes	
Earth fault protection	RCD	
DC-current injection	< 0,5% I _n	
Required phases, grid connections	3 (L1, L2, L3, N, PE)	
Number of feed-in phases	3	
Grid voltage monitoring	3-phase	
Type of AC connection	Spring clamps	
PERFORMANCE		
Stand-by consumption	< 4.0 W	
Night-time consumption	< 1 W	
Maximum efficiency	98,16%	
European efficiency	97,8%	
Topology	Transformerless	

OTHER

DC-switch	Integrated
DC overvoltage category	II
AC overvoltage category	III
Data interface	WIFI, LAN, RS485, Multifunctional dry contact, 4 x digital in, 2 x digital in/out
Display	LCD dot matrix 128 x 64 with backlight
Cooling	Convection
IP degree of protection	IP 65
Max. operating altitude	2000 m
Max. relative humidity	4 - 100% (condensing)
Typical noise	< 35 dB
Operating temperature range	-25°C ... 60°C (40° @ full load)
Type of installation	Wall mounting
Dimensions (height x width x depth)	570 x 440 x 200 mm
Weight	22 kg

SAFETY / STANDARDS

Protection class	1
Overload behavior	Working point adjustment
Certificates	CE, VDE-AR-N 4105:2018-11, EN 50549 further certificates: www.rct-power.com
EMC	EN61000-6-2, EN61000-6-3, EN61000-3-2, EN61000-3-3
Safety	EN/IEC62109-1, EN/IEC62109-2

BLOCK DIAGRAM

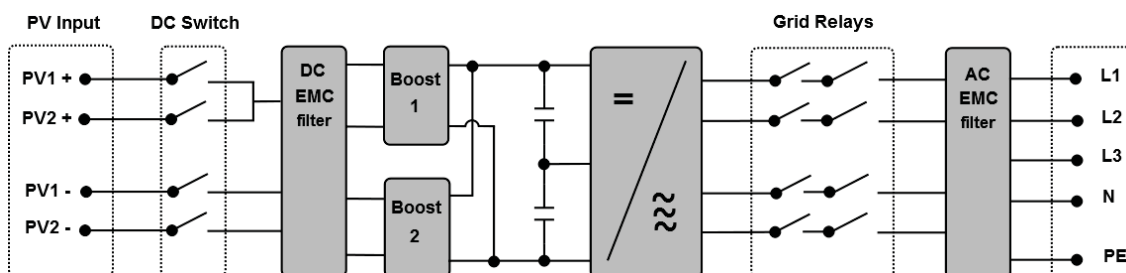

RCT Power GmbH

Line Eid Str. 1

78467 Konstanz, Deutschland

Tel.: +49 (0)7531 996 77-0

Mail: info@rct-power.com

Internet: www.rct-power.com